

Thermal Monocular Camera

User's Manual











Foreword

General

This manual introduces the functions and operations of Thermal Monocular Camera (hereinafter referred to as "the Camera"). Read carefully before using the device, and keep the manual safe for future reference.

Safety Instructions

The following signal words might appear in the manual.

Signal Words	Meaning
 DANGER	Indicates a high potential hazard which, if not avoided, will result in death or serious injury.
 WARNING	Indicates a medium or low potential hazard which, if not avoided, could result in slight or moderate injury.
 CAUTION	Indicates a potential risk which, if not avoided, could result in property damage, data loss, reductions in performance, or unpredictable results.
 ESD	Electrostatic Sensitive Devices. Indicates a device that is sensitive to electrostatic discharge.
 ELECTRIC SHOCK	Indicates dangerous high voltage. Take care to avoid coming into contact with electricity.
 LASER RADIATION	Indicates a laser radiation hazard. Take care to avoid exposure to a laser beam.
 TIPS	Provides methods to help you solve a problem or save time.
 NOTE	Provides additional information as a supplement to the text.

Revision History

Version	Revision Content	Release Time
V1.0.0	First release.	August 2024

Privacy Protection Notice

As the device user or data controller, you might collect the personal data of others such as their face, fingerprints, and license plate number. You need to be in compliance with your local privacy protection laws and regulations to protect the legitimate rights and interests of other people by implementing measures which include but are not limited: Providing clear and visible identification to inform people of the existence of the surveillance area and provide required contact information.

About the Manual

- The manual is for reference only. Slight differences might be found between the manual and the product.
- We are not liable for losses incurred due to operating the product in ways that are not in

compliance with the manual.

- The manual will be updated according to the latest laws and regulations of related jurisdictions. For detailed information, see the paper user's manual, use our CD-ROM, scan the QR code or visit our official website. The manual is for reference only. Slight differences might be found between the electronic version and the paper version.
- All designs and software are subject to change without prior written notice. Product updates might result in some differences appearing between the actual product and the manual. Please contact customer service for the latest program and supplementary documentation.
- There might be errors in the print or deviations in the description of the functions, operations and technical data. If there is any doubt or dispute, we reserve the right of final explanation.
- Upgrade the reader software or try other mainstream reader software if the manual (in PDF format) cannot be opened.
- All trademarks, registered trademarks and company names in the manual are properties of their respective owners.
- Please visit our website, contact the supplier or customer service if any problems occur while using the device.
- If there is any uncertainty or controversy, we reserve the right of final explanation.

Important Safeguards and Warnings

This section introduces content covering the proper handling of the device, hazard prevention, and prevention of property damage. Read carefully before using the device, and comply with the guidelines when using it.

Transportation Requirements



- Transport the Camera within the allowed humidity and temperature conditions.
- Do not fall, squeeze, violently vibrate or immerse the device in liquid when transporting. Gently pick and place the Camera when moving, prevent the internal equipment becoming damaged or cable connection becoming loose.
- Do not transport the Camera without package. Use the factory default package or material of equal quality to pack the Camera when transporting it, otherwise the Camera can become easily damaged.

Storage Requirements



- Store the Camera within the allowed humidity and temperature conditions.
- Do not place the device in a humid, dusty or extremely hot or cold site that has strong electromagnetic radiation or unstable illumination.
- Do not squeeze, violently vibrate or immerse the device in liquid.
- Do not mechanically vibrate or crash when storing.
- Store the Camera in a ventilated place that has no strong electromagnetic radiation.
- For long-term storage of the battery, make sure that it is fully charged every half year to ensure the battery quality. Otherwise, damage may occur.

Operation Requirements



- Prevent liquid from flowing into the Camera to avoid damage to the internal components.
- Do not stuff foreign materials into the Camera to prevent a short circuit which could result in the Camera being damaged or people becoming injured.
- Do not expose the device to high electromagnetic radiation or dusty environments.
- Do not aim the lens at the sun or any other bright light.
- Improper use or replacement of the battery may result in explosion hazard.
- Do not charge other battery types with the supplied charger. Confirm there is no flammable material within 2 m of the charger during charging.
- Make sure that the plug is properly connected to the power socket.
- Do not connect multiple devices to one power adapter, to avoid over-heating or fire hazards caused by overload.
- If smoke, odor, or noise arises from the device, immediately turn off the power, unplug the power cable, and contact the service center.



- Do not dismantle the Camera. The internal components can only be repaired by a qualified professional. Dismantling it without professional assistance might cause water seeping in or might result in the Camera producing poor quality images.
- Operating temperature: $-30\text{ }^{\circ}\text{C}$ to $+55\text{ }^{\circ}\text{C}$ ($-22\text{ }^{\circ}\text{F}$ to $+131\text{ }^{\circ}\text{F}$), and the operating humidity shall be 95% or less.

Maintenance and Repair Requirements



DANGER

- Prevent liquid from flowing into the Camera to avoid damage to the internal components. In case the liquid enters the Camera, immediately stop using the Camera, cut off the power, and disconnect all the cables, and then contact your local customer service center.
- Use the accessories regulated by the manufacturer. The Camera should be maintained by qualified professionals.
- Make sure to cut off the power before cleaning the Camera, to prevent electric shock.



WARNING

If the Camera malfunctions, contact your local customer service center. Do not dismantle the Camera.



- Clean the Camera body with a piece of soft dry cloth. For any dirt that is hard to remove, pick up a piece of clean and soft cloth, dip it into a little neutral detergent and gently wipe the dust away. After that, wipe away all the remaining liquid on the Camera with another dry cloth. Never use volatile solvents such as alcohol, benzene and thinner, or cleaners that are strong and abrasive. Otherwise, the Camera's surface coating will be damaged and its working performance will be encumbered.
- Save the factory package of the Camera. When the Camera malfunctions, pack the Camera with the factory package and send to the dealer.

Laser Requirements



LASER RADIATION

Laser can cause damages to eyes. Do not look directly at the laser beam or observe the beam with optical devices when the laser is on.

Table of Contents

Foreword	I
Important Safeguards and Warnings.....	III
1 Product Introduction	1
2 Structure	2
2.1 Packing List.....	2
2.2 Device Description.....	2
3 Basic Operation	5
3.1 Starting and Shutdown	5
3.1.1 Manual Starting and Shutdown	5
3.1.2 Auto Shutdown.....	5
3.2 Configuring the Camera.....	5
3.2.1 Menu Description	5
3.2.2 Image Adjustment.....	6
3.2.2.1 Adjusting Diopter	6
3.2.2.2 Adjusting Focus	7
3.2.2.3 Setting Color Palettes.....	7
3.2.2.4 Setting Digital Zoom.....	9
3.2.2.5 Setting Status Bar Display.....	10
3.2.2.6 Setting Screen Brightness	10
3.2.2.7 Setting Image Brightness	10
3.2.2.8 Setting Contrast.....	10
3.2.2.9 Setting Sharpness.....	10
3.2.3 Setting Wi-Fi Connection	10
3.2.4 Setting Hot Point.....	12
3.2.5 Setting Forest Mode.....	12
3.2.6 Setting Ranging Mode.....	12
3.2.7 Setting Laser Ranging	13
3.2.7.1 Measurement Considerations	13
3.2.7.2 Setting Laser Ranging Mode.....	14
3.2.8 Setting Language	14
3.2.9 Setting DPC.....	14
3.2.10 Function Settings.....	15
3.2.11 System Settings	15
3.3 Video and Snapshot	16
3.3.1 Recording Videos.....	16

3.3.2 Capturing Images	16
3.3.3 Exporting File	16
3.4 Charging	17
4 System Update	18
4.1 Upgrading Manually	18
4.2 Upgrading through App	18
Appendix 1 Compliance Notice	19

1 Product Introduction

The thermal monocular camera captures sharp thermal imaging at a fast frame rate for smooth, impeccable vision on running targets and from moving vehicles. Designed to increase situational awareness at any time of day, the camera can detect humans, animals, and objects in complete darkness, haze, or through glaring light, equipping law enforcement professionals, hunters, and outdoor enthusiasts with reliable thermal imaging in tough conditions. Featuring the laser range finder, the Camera with LFR can accurately measure the target distance. It is widely used in outdoor scenarios for hunting, rescue, animal observation, and more.

2 Structure

2.1 Packing List

Figure 2-1 Packing list

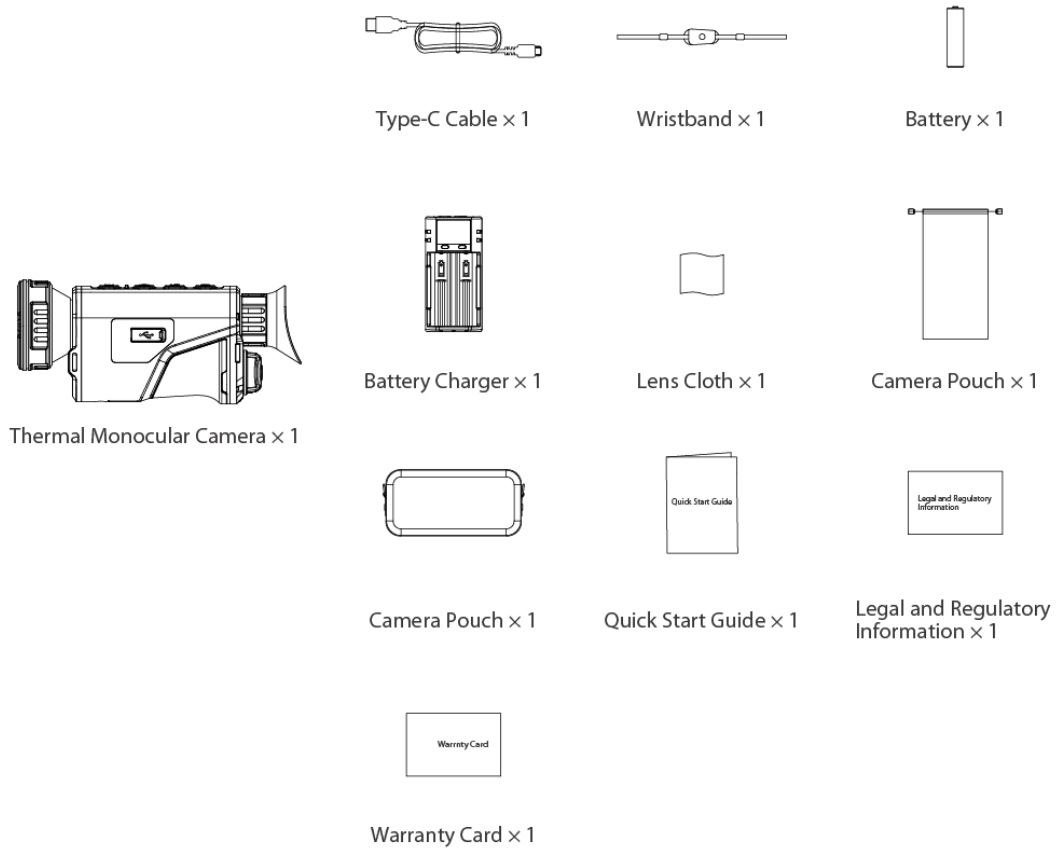

2.2 Device Description

Figure 2-2 Button description (with LFR)

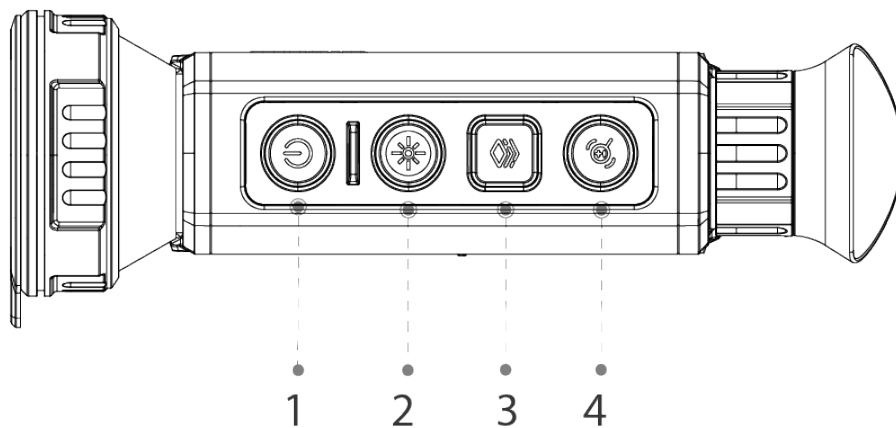

Figure 2-3 Button description (without LFR)

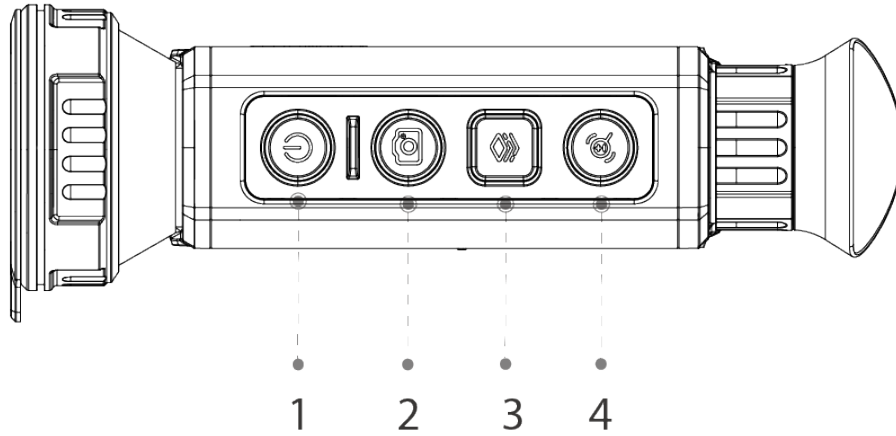

Table 2-1 Button description (with LFR)



No.	Name	Description
1	Power button	<ul style="list-style-type: none"> • Press and hold to start or shut down the Camera. • Press to enable or disable the suspend mode.
2	Laser button	<ul style="list-style-type: none"> • Press to enable the laser ranging mode. • press and hold to record videos. <p> DANGER Laser can cause damages to eyes. Do not look directly at the laser beam or observe the beam with optical devices when the laser is on.</p> <p></p> <ul style="list-style-type: none"> • Make sure that you have set the laser ranging mode before enabling the function. For detail, see "3.2.7 Setting Laser Ranging". • The ranging function is only available when the distance is longer than 10 m.
3	Menu button	<ul style="list-style-type: none"> • Press and hold to go to the main menu. • Press to select the color palettes.
4	Zoom button	<ul style="list-style-type: none"> • Press and hold to manually adjust the shutter. • Press for digital zoom.
2 + 4	Laser button + Menu button	Press the two buttons at the same time to capture images.

Table 2-2 Button description (without LFR)

No.	Name	Description
1	Power button	<ul style="list-style-type: none"> • Press and hold to start or shut down the Camera. • Press to enable or disable the suspend mode.
2	Capture button	<ul style="list-style-type: none"> • Press and hold to record videos. • Press to capture images.
3	Menu button	<ul style="list-style-type: none"> • Press and hold to go to the main menu. • Press to select the color palettes.

No.	Name	Description
4	Zoom button	<ul style="list-style-type: none"> • Press and hold to manually adjust the shutter. • Press for digital zoom.

Figure 2-4 Port description

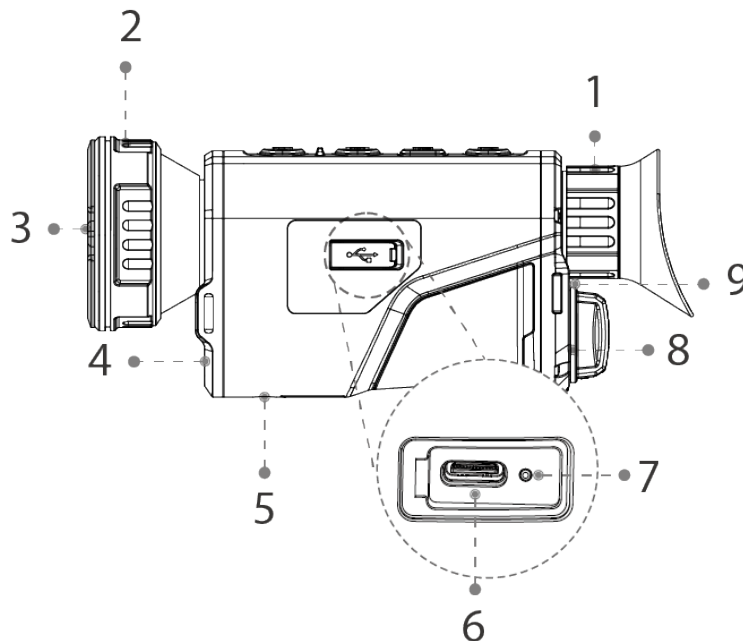



Table 2-3 Port description

No.	Name	Description
1	Diopter adjustment ring	Adjust the diopter according to your eyesight.
2	Focus ring	Manually rotate the lens to adjust the focus for a clear image.
3	Protective cover	Dust prevention. Close the cover when not using the Camera.
4	Laser module	<p>Measures the distance between the Camera and the target.</p> <p> This function is only available on the Camera with a laser range finder.</p> <p> DANGER Laser can cause damages to eyes. Do not look directly at the laser beam or observe the beam with optical devices when the laser is on.</p>
5	Tripod nut	For tripod installation.
6	Type-C port	Connects to a data cable for charging.
7	Charging indicator	<ul style="list-style-type: none"> • Red and green lights flashing alternately: charging error. • Red light on: charging. • Green light on: fully charged. • Off: not connected to data cable to charge.
8	Battery compartment	The place for holding the battery.
9	MIC	Collects sound.

3 Basic Operation

3.1 Starting and Shutdown

3.1.1 Manual Starting and Shutdown

Press and hold the power button to start or shut down the Camera; press the power button to suspend or weak up the Camera.



After starting the Camera, remove the protective cover of the lens.

- When the Camera is off, press and hold the power button to start it.
- When the Camera is on, press and hold the power button to shut down it.
- When the Camera is on, press the power button to suspend the Camera.
- When the Camera is in suspend mode, press the power button to weak up it.

3.1.2 Auto Shutdown

Step 1 Press and hold  to go to the main menu.

Step 2 Press  or  to select .







For the camera with LFR, press  or  to select .

Step 3 Press  to go to the **System Settings** configuration screen.

Step 4 Press  or  to select .



For the camera with LFR, press  or  to select .

Step 5 Press  to set the auto shutdown time. If there is no operation in the configured time, the Camera will automatically shut down.

Step 6 Press and hold  to save the configuration and exit.

After finishing the auto shutdown settings, the Camera will suspend first, and then shut down.



3.2 Configuring the Camera

3.2.1 Menu Description

When the Camera is on, press and hold  to enter the main menu. Functions of all buttons are as follows.

- Press  to move upward the cursor.



For the camera with LFR, press  to move upward the cursor. In this section, we use  as an example.



- Press  to move downward the cursor.
- Press  to confirm.
- Press and hold  to exit.

Figure 3-1 Menu description (with LFR)

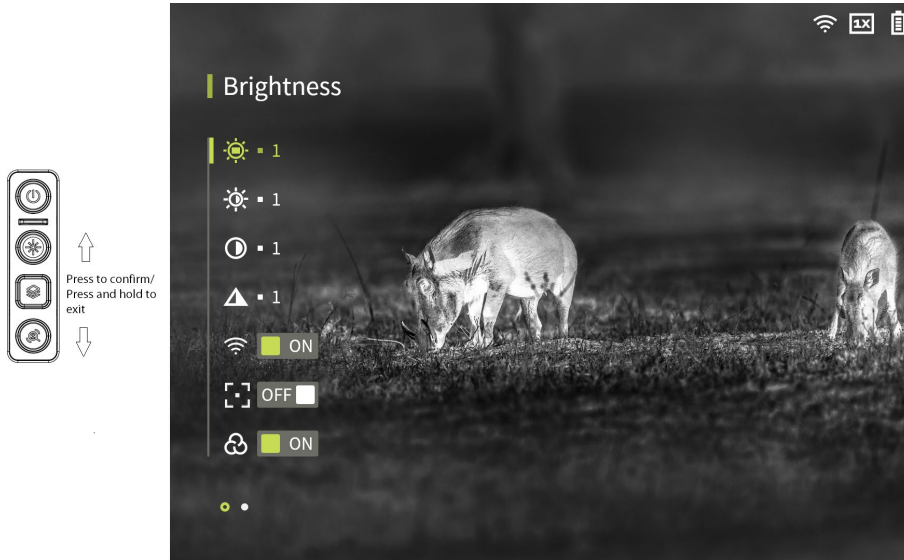
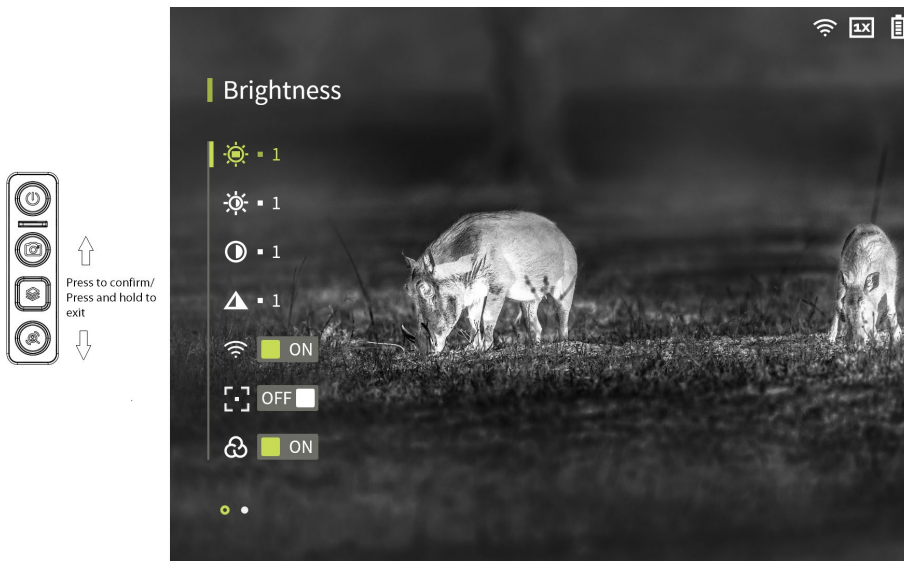

Figure 3-2 Menu description (without LFR)



3.2.2 Image Adjustment

3.2.2.1 Adjusting Diopter

To get clear images, rotating the diopter adjustment knob to fit your eyesight.



For the first-time use, adjust the diopter before configuring the functions.

Step 1 Aim the lens at the target, and then make your eyes close to the eyeshade.

Step 2 Adjust clockwise or counterclockwise the knob according to your eyesight.

Figure 3-3 Adjust diopter

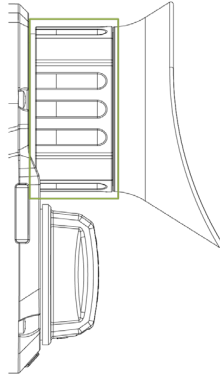

3.2.2.2 Adjusting Focus

Rotate the focus ring to get a clear view. This function is only available on the models with adjustable lens.

Step 1 Aim the thermal lens to the target.

Step 2 Adjust clockwise or counterclockwise the focus ring until the view is clear.



During the adjustment, do not touch the lens to avoid smudging it; otherwise it may affect the image quality.

Figure 3-4 Adjust focus

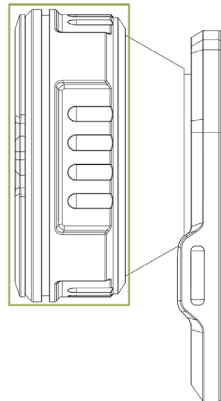

3.2.2.3 Setting Color Palettes

Select the color palettes, which adds color to the thermal image and uses color to indicate the temperature.

On the viewing screen, press  to select the color palettes.

- **White Hot:** The objects with high temperature are white. The higher the temperature, the brighter the color.
- **Alarm:** The objects with high temperature are red. The objects can stand out.
- **Iron Red:** The objects with high temperature are red. The higher the temperature, the brighter the color.
- **Black Hot:** The objects with high temperature are black. The higher the temperature, the darker the color.

- Sepia: The objects with high temperature are brown. The higher the temperature, the darker the color.
- Green Hot: The objects with high temperature are green. The higher the temperature, the darker the color.

Figure 3-5 White hot



Figure 3-6 Alarm



Figure 3-7 Iron red



Figure 3-8 Black hot



Figure 3-9 Sepia



Figure 3-10 Green hot





3.2.2.4 Setting Digital Zoom

Digital zoom helps to zoom in the image.





On the viewing screen, press  to do digital zoom, and the image changes.

3.2.2.5 Setting Status Bar Display

Step 1 On the main menu, press  or  to select  > **OSD**.



Step 2 Press  to enable OSD to display the status bar.

Table 3-1 Description of status bar

Icon	Name	Description
	Wi-Fi	<ul style="list-style-type: none">: Wi-Fi is disabled.: Wi-Fi is enabled.
	Digital zoom	Supports 1×, 2×, 4× and 8× digital zoom. The number might differ depending on models.
	Battery level	Displays the battery level in real time.

3.2.2.6 Setting Screen Brightness



Adjusts the overall screen brightness. The higher the level is, the brighter the screen will be.

Step 1 On the main menu, press  or  to select .

Step 2 Press  to select the brightness level. The higher the level is, the brighter the screen will be.

3.2.2.7 Setting Image Brightness



Adjusts the image brightness. The higher the level is, the brighter the image will be.

Step 1 On the main menu, press  or  to select .

Step 2 Press  to select the brightness level. The higher the level is, the brighter the image will be.

3.2.2.8 Setting Contrast



You can set the contrast. The higher the level is, the more the contrast will be between bright and dark areas.

Step 1 On the main menu, press  or  to select .

Step 2 Press  to select the contrast level.

3.2.2.9 Setting Sharpness

Adjusts the sharpness of picture edges. The higher the level is, the clearer the picture edges will be.

Step 1 On the main menu, press  or  to select .

Step 2 Press  to select the sharpness level. The higher the level is, the clearer the picture edges will be.

3.2.3 Setting Wi-Fi Connection

After enabling Wi-Fi connection, you can connect your phone to the hotspot of the Camera, and

then access the Camera with the app.

The frequency bands and modes and the nominal limits of transmitted power (radiated and/or conducted) applicable to this radio device are the following:

Wi-Fi 2.4 GHz (2.4 GHz to 2.4835 GHz)	20 dBm
---------------------------------------	--------



Some cameras will automatically disable the Wi-Fi function when the battery level is lower than 15%.

Procedure

Step 1 Scan the QR code with your smart phone to install the app.

Figure 3-11 QR code



Step 2 On the main menu, press or to select .

Step 3 Press to enable the Wi-Fi function.

- Wi-Fi name: model number + serial number.
- Wi-Fi password: 12345678.



You can find the serial number on the Camera and the label of the packing box.

Step 4 Log in to the app.



Add access devices according to the prompt.

Related Operations

- Change the password
 1. On the main menu, press or to select .
 2. Press to go to the **System Settings** configuration screen.
 3. Select > .
 4. Press to go to the password set screen.
 5. Press to select the digital to be set, and press or to set the value.
- Reset the password
 1. On the main menu, press or to select .
 2. Press to go to the **System Settings** configuration screen.
 3. Select > .
 4. Press to reset the password.

3.2.4 Setting Hot Point



Tracks the point with the highest temperature in real time.

Step 1 On the main menu, press  or  to select .

Step 2 Press  to enable or disable the hot point function.

After enabling the hot point function, the hot point icons will automatically locate at the point with the highest temperature in the image.

3.2.5 Setting Forest Mode

Step 1 On the main menu, press  or  to select .

Step 2 Press  to enable or disable Forest Mode.

Forest mode stands out the targets with high temperature, which makes it easier to find out the targets.



3.2.6 Setting Ranging Mode

After setting the ranging mode, the Camera can measure the range towards targets.



This function is only available on the models without laser range finders. For models with laser range finders, see "3.2.7 Setting Laser Ranging".



To guarantee the measurement accuracy, keep your hand steady when measuring the range.

Step 1 On the main menu, press  or  to select .

Step 2 Press  to go to the **Ranging Mode** configuration screen.

Step 3 Press  or  to move the green lines to the top and bottom of the target to get the distance between the target and the Camera.

Use the following fig as an example:

- If the target is a wolf, it is 30 m away from Camera.
- If the target is a rabbit, it is 11 m away from Camera.
- If the target is a wild boar, it is 33 m away from Camera.
- If the target is a deer, it is 48 m away from Camera.

Figure 3-12 Ranging Mode



3.2.7 Setting Laser Ranging

This function is only available on the models with laser range finders. For models without laser range finders, see "3.2.6 Setting Ranging Mode".



Laser can cause damages to eyes. Do not look directly at the laser beam or observe the beam with optical devices when the laser is on.

3.2.7.1 Measurement Considerations

Measurement targets

The Camera is suitable for measuring the distance between the camera and the targets with high reflectivity (such as road signs on highways), the targets with moderate reflectivity (such as wall) and the targets with low reflectivity (such as tree, golf flag, utility pole, and animal). When the reflectance is reduced to a certain extent, the range will be reduced accordingly.

Factors that influence ranging capability

- Target reflectivity: Generally, the higher the reflectivity of the target, the better the ranging ability. For example, the measuring range of the Camera is 1,500 m for a target with moderate reflectivity, which can be up to 1,800 m for a target with high reflectivity, and 600 m for the targets with low reflectivity. (It might fail to measure the target that hardly generates diffuse reflection, such as water surface.)
- Target shape: When a target is too small or uneven, the ranging ability will decrease.
- Measuring angle: The measurement is more accurate when the reflection surface of target is vertical to the laser emission's direction. If you use the Camera under some extreme conditions, the measurement might be inaccurate.
- Measuring environment: The environment factors include sunshine intensity, the concentration

of water vapor in the air and suspended particles (such as rain, fog, snow, fog and haze).

The range ability of the Camera defined under the following conditions

- The measurement target is with moderate reflectivity, such as walls.
- The reflection surface of target is vertical to laser emission direction.
- The weather condition is sunny but not under the condition of direct sunlight.
- The reflection area is larger than 2 m × 2 m.

3.2.7.2 Setting Laser Ranging Mode

After setting the laser ranging mode, the Camera can measure the range towards targets.



To guarantee the measurement accuracy, keep your hand steady when measuring the range.

Step 1 On the main menu, press or to select .

Step 2 Press to select the laser ranging mode.

- Once: After pressing the laser button, the Camera measures the distance between the camera and the target once.
- Continue: After pressing the laser button, the Camera continuously measures the distance between the Camera and the target in 15 s.

3.2.8 Setting Language

You can select the language as needed.

Step 1 On the main menu, press or to select .

Step 2 Press to go to the language selection screen.

Step 3 Press to select the language as needed.

Step 4 Press to save and exit.

3.2.9 Setting DPC

After enabling DPC (Defective Pixels Correction), you can correct the defective pixels in the image.

Step 1 On the main menu, press or to select .

Step 2 Press to go to the **Function Set** configuration screen.

Step 3 Press or to select .

Step 4 Press to go to the **DPC** configuration screen.

- Auto: The Camera automatically corrects the defective pixels in the image.
 1. Select **Auto**.
 2. Press to start the auto correction.
 3. Follow the screen instructions to close the lens cover.
 4. Press to save the configurations.
- Manual: You need to correct the defective pixels manually.
 1. Press to select X-axis and Y-axis.
 2. Press and hold or to calibrate the defective pixels.

3. Press and hold  to save the configuration.



The center of the cursor is the position of the defective pixel.

- Restore: The DPC configuration is restored to the primary state.

3.2.10 Function Settings



















- Step 1** On the main menu, press  or  to select .
- Step 2** Press  to go to the **Function Set** configuration screen.
- Step 3** Press  or  to select the function to be configured.

Table 3-2 Function Settings

Function	Description
Burning Warning ()	Press  to enable the burning warning function. When the lens is in the risk of burning, a note will be displayed on the screen and the shutter will be off automatically.
Logo ()	Press  to enable logo display, and the logo will be display when the camera is starting.
OSD ()	Press  to enable OSD display, and the status bar is displayed.
Auto FFC ()	Press  to enable FFC (Flat-Field Calibration) mode, and the camera calibrates image automatically at regular intervals.
DPC ()	Press  to enable DPC (Defective Pixels Correction), and you can correct the defective pixels in the image. For details, see "3.2.9 Setting DPC".
MIC ()	Press  to enable or disable MIC.

3.2.11 System Settings























- Step 1** On the main menu, press  or  to select .
- Step 2** Press  to go to the **System Set** configuration screen.
- Step 3** Press  or  to select the parameter to be configured.

Table 3-3 System settings

Parameter	Description
Auto Standby ()	Press  to select the auto standby time. If there is no operation in the configured time, the Camera will automatically suspend.
Auto Shutdown ()	Press  to select the auto shutdown time. If there is no operation in the configured time, the Camera will automatically shut down.
USB Mode ()	Press  to enable the USB mode. <ul style="list-style-type: none"> • On: The Camera can be used as a storage device. • Off: Charge the Camera.
Unit Set ()	Press  to select the unit from Yd and Metre .
Time Display ()	Press  to select the display format of the time.

Parameter	Description
Time Set 	Press  to select the date or time to be configured; press  or  to set the value.
Version 	View the device information such as serial number and version number.
Restore Default 	Restore the device to default configuration.  This operation will restore the camera to default configuration. Please be careful.



3.3 Video and Snapshot

3.3.1 Recording Videos

On the viewing screen, press and hold  for 3 seconds to start recording a video. The recording icon flashes on the screen and the recording time is display.

Press and hold  again for 3 seconds to stop the recording. When the recording stops, the recording time will display normally.



For the camera with LFR, press and hold  to start recording a video; press and hold  again for 3 seconds to stop the recording .

3.3.2 Capturing Images

On the viewing screen, press  to capture images.

The screen will display an icon when the capturing succeeds.



For the camera with LFR, press  and  at the same time to capture images.

3.3.3 Exporting File

Exports the recorded and captured files.

Step 1 Connect the Camera to the computer through a Type-C data cable.
The driver will automatically be installed for first-time connection.



- Connect the cables before starting the Camera. Do not hot swap the Type-C port of the Camera.
- Select **On** on the **USB Mode** configuration screen after connecting the Camera to the computer.

Step 2 On the computer desktop, double-click **My Computer**, and then open the Camera disk at a mobile storage device.

Step 3 Select the files to export and copy them to the computer.

The specific computer client is required for playing the exported files.

Step 4 Disconnect the Type-C data cable with the computer.

After connecting the Camera to the computer, images can be displayed on the Camera, but the functions of recording and capturing will not be available.

3.4 Charging

The start bar will display battery information after the Camera starts. When the battery is low, charge the Camera timely to make sure the normal function.

- When charging the Camera, keep the battery temperature 0 °C to +60 °C (+32 °F to +140 °F).

Otherwise the charging function will be automatically disabled.

- Charge the Camera with the Type-C data cable that comes with the delivery.

Step 1 Open the sealing cover of the Type-C port when charging.







Step 2 Connect the Type-C cable to the Type-C port to charge the Camera.

The charging indicator states:

- Red light on: charging.
- Green light on: fully charged.
- Off: not connected to data cable to charge.

4 System Update

4.1 Upgrading Manually

- Step 1 On the main menu, press  or  to select .
- Step 2 Press  to go to the **System Settings** configuration screen.
- Step 3 Press  or  to select .
- Step 4 Press  to select **On**.
- Step 5 Connect the Camera and your computer, and then copy the upgrading file to the Camera.
- Step 6 Disconnect the Camera and your computer, and then restart the Camera.

4.2 Upgrading through App

When the app detects new program for upgrading, it will prompt a notification. Tap **Upgrade** to upgrade the system.

Appendix 1 Compliance Notice

The thermal series products might be subject to export controls in various countries or regions, including without limitation, the United States, European Union, United Kingdom and/or other member countries of the Wassenaar Arrangement. Please consult your professional legal or compliance expert or local government authorities for any necessary export license requirements if you intend to transfer, export, re-export the thermal series products between different countries.