

BRESSER® PC Weather Station with 5-in-1 Sensor

Art. No. 7002571



 **INSTRUCTION MANUAL**

TABLE OF CONTENTS

INTRODUCTION	4
OVERVIEW	4
INSTALLATION	7
OTHER SETTING OF THE CONSOLE	10
SETTING ALARM TIME	11
ACTIVATING ALARM AND TEMPERATURE PRE-ALARM FUNCTION	11
TEMPERATURE / HUMIDITY FUNCTION & TREND	12
WIRELESS SENSOR SIGNAL RECEIVING	12
WIND	13
WEATHER INDEX	13
WEATHER FORECAST	15
BAROMETRIC PRESSURE	15
RAINFALL	16
HISTORY GRAPH	17
MAX / MIN DATA RECORD	18
PAST 24 HOURS HISTORY DATA	18
WEATHER ALERT SETTING	18
POINTING THE WIRELESS 5-IN-1 SENSOR TO SOUTH	20
DATA LOG	20
PC SOFTWARE	21
MAINTENANCE	22
BATTERY REPLACEMENT	22
CLEANING THE RAIN COLLECTOR	22
CLEANING THERMO-HYGROSENSOR OF WIRELESS 5-IN-1 SENSOR	22
PRECAUTIONS	23
SPECIFICATIONS	24
MAIN CONSOLE	24
WIRELESS 5-IN-1 SENSOR	26

INTRODUCTION

Thank you for selecting full weather station with 5-in-1 professional sensor and PC connection. This product offers professional weather observers or serious weather enthusiasts robust performance with a wide range of options and sensor. You can save your own location's weather information in your PC through the "WEATHER TOOL" PC software.

This full weather station transmits temperature, humidity, wind speed / direction and rainfall. Also, it can support up to 7 optional wireless thermo-hygro sensor (not included), transmits your desired location's temperature & humidity records to the console. Both sensors are fully assembled and calibrated for your easy installation. They send data at a low power radio frequency to the console from up to 150m / 450 feet away (line of sight).

In the main console, a multi-function processor is embedded to analyze the received weather data and these real-time data can store in the built-in data logger instantly. The wide-viewing-angled LCD display shows informative weather readings with advanced features, such as high/low alert alarm, different weather index, multi-functional bar chart and MAX/MIN records. With the built-in sunrise/sunset and moon phase features, this system is truly a remarkably personal yet professional weather station for your own backyard.

Note:
This instruction manual contains useful information on the proper use and care of this product. Please read this manual through to fully understand and enjoy its features, and keep it handy for future use.

OVERVIEW

MAIN CONSOLE

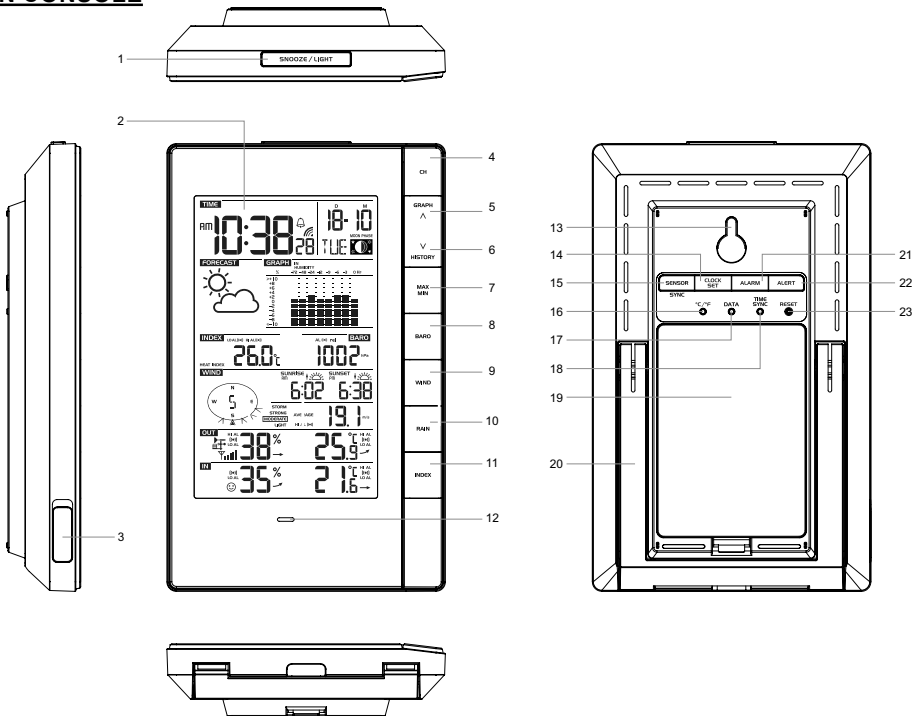

- | | | |
|-----------------------------|---|-------------------------|
| 1. [SNOOZE / LIGHT] KEY | 9. [WIND] KEY | 17. [DATA] KEY |
| 2. LCD DISPLAY | 10. [RAIN] KEY | 18. [TIME SYNC] KEY |
| 3. MICRO-USB PORT | 11. [INDEX] KEY | 19. BATTERY COMPARTMENT |
| 4. [CH] KEY | 12. ALERT LIGHT | 20. TABLE STAND |
| 5. [GRAPH / \wedge] KEY | 13. WALL MOUNT | 21. [ALARM] KEY |
| 6. [HISTORY / V] KEY | 14. [CLOCK SET] KEY | 22. [ALERT] KEY |
| 7. [MAX / MIN] KEY | 15. [SENSOR / SYNC] KEY | 23. [RESET] KEY |
| 8. [BARO] KEY | 16. [$^{\circ}$ C / $^{\circ}$ F] KEY | |

LCD DISPLAY

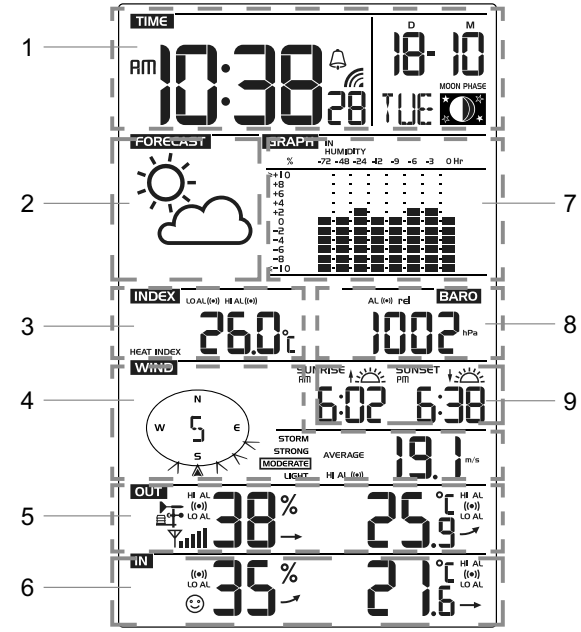

DISPLAY SECTIONS

1. Time, calendar & moon phase
2. Weather forecast
3. Weather index
4. Wind direction & speed
5. Outdoor temperature & humidity
6. Indoor temperature & humidity
7. Multi-function historical bar chart
8. Barometer & Rainfall
9. Sunrise/sunset

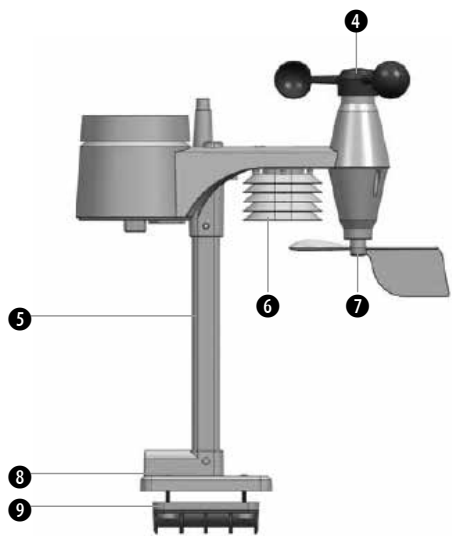
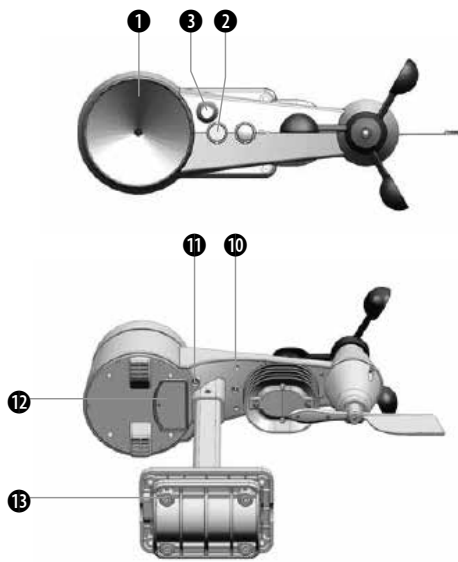

WIRELESS 5-IN-1 SENSOR

1. Rain collector
2. Level grader
3. Antenna
4. Wind cups
5. Mounting rod
6. Thermo-Hygrosensor
7. Wind vane
8. Mounting base
9. Tube clamp
10. Red function indicator
11. [RESET] key
12. Battery compartment and cover
13. Screws for the tube clamp

RAIN GAUGE

14. Funnel
15. Tilt plate
16. Rain sensor
17. Water drain

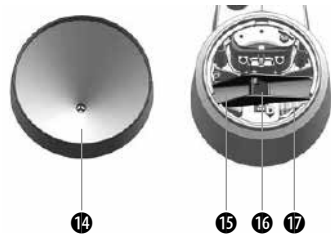

TEMPERATURE & HUMIDITY SENSOR

18. Radiation shield
19. Sensor housing
(Temperature and humidity sensor)

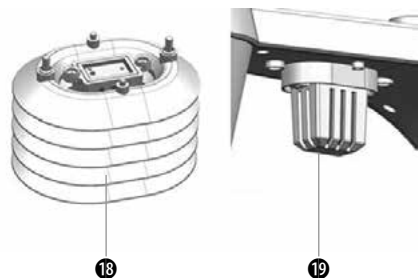

WINDSENSOR

- 20. Wind cups (Anemometer)
- 21. Wind vane

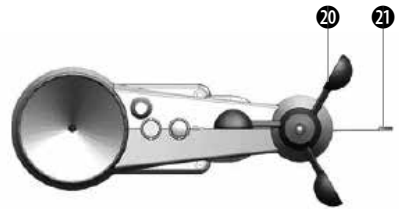

INSTALLATION

5-IN-1 WIRELESS SENSOR

The wireless 5-in-1 sensor measures wind-speed, wind-direction, rainfall, temperature and humidity for you. It's fully assembled and calibrated for an easy installation.

INSTALLING BATTERIES

Loosen the screws of the wireless 5-in1 sensor at the bottom of the battery compartment cover and remove the cover.

Insert the batteries according to the right polarity (+/-) as shown in the compartment. Replace the battery compartment cover and tighten the screws by hand.

NOTE:

- 1. Make sure that the waterresitant O-ring is placed below the cover in right way to prevent water from entering.
- 2. The red LED Light begins to flash every 12 seconds.

MONTAGEBASIS & -STAB ANBRINGEN

Sep 1

Put the top side of the rod into the square hole of the wireless 5-in-1 sensor.

NOTE:

Make sure that the marking on the rod and on the sensor meet together.

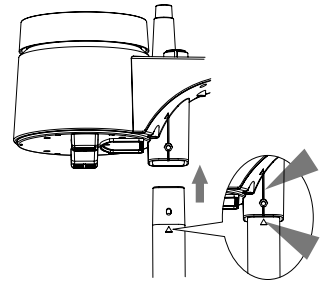

Step 2

Insert the nuts in the hexagonal holes on the sensor first. Then insert the screws on the opposite side and tighten them by hand with a screwdriver.

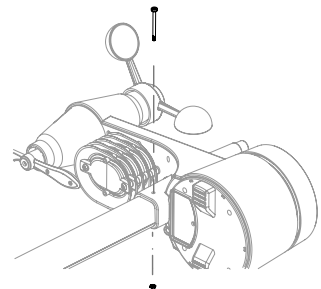

Step 3

Put the other end of the rod into the square hole of the mounting base.

NOTE:

Make sure that the marking on the rod and on the sensor meet together.

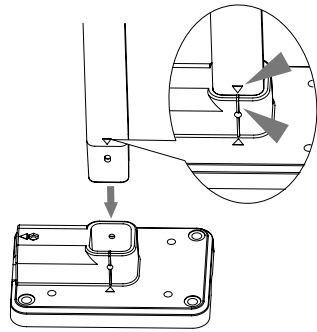

Step 4

Insert the nuts in the hexagonal holes on the mounting base first. Then insert the screws on the opposite side and tighten them by hand with a screwdriver.

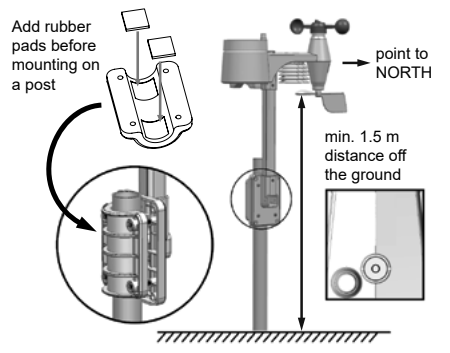

Install the wireless outdoor sensor to an open location with no obstructions above and around the sensor for accurate rain and wind measurement. Install the sensor with the shorter end facing north so that the wind vane is correctly oriented.

Mount the mounting base and the supplied tube clamp to a post or pole that is at least 1.5 m off the ground.

MOUNTING REQUIREMENTS

1. Install the sensor at least 1.5m off the ground for better and more accurate wind measurements.
2. Choose an open area within 150 meters from the main console.
3. Install the sensor as level as possible to achieve accurate rain and wind measurements. Use the level indicator on the sensor to ensure a level installation.
4. Mount the sensor with the wind meter end pointing to North to correctly orient the direction of the wind vane.



A. Mounting on a post* (diam.: approx. 25 - 33 mm)



A. Mounting on a railing.

MAIN CONSOLE

Your main console can pairing up with the wireless 5-IN-1 outdoor weather sensor and up to 7 optional wireless hygro-thermo outdoor sensors. (not included)

Powering up the main console

1. Remove the battery door on the back side of the main unit.
2. Insert 6 new AA batteries and replace the battery door.
3. Once the batteries are inserted, the segments of the LCD will be shown.

NOTE:

- If no display appears on the LCD after inserting the batteries, press [**RESET**] key by using a pointed object.

Pairing of wireless 5-IN-1 weather sensor with main console

After insertion of batteries, the main console will automatically search and connect the wireless 5-IN-1 sensor (antenna blinking). Once the connection is successful, antenna mark and readings for outdoor temperature & humidity, wind speed, wind direction and rainfall will appear on the display.

Changing batteries and manual pairing of sensor

Whenever you changed the batteries of the wireless 5-IN-1 sensor, pairing must be done manually.

1. Change all the batteries to new ones in the sensor.
2. Press [**CH**] until the  icon appear in the Outdoor section
3. Press [**SENSOR / SYNC**] key.
4. Press [**RESET**] key on the sensor.

NOTE:

Pressing [**RESET**] key at bottom of wireless 5-IN-1 sensor will generate a new ID code for pairing purpose. So you also need to press the [**SENSOR / SYNC**] key on the console to repairing up the sensor.

Pairing the wireless sensor(s) with the console

The console will automatically search and pair up your wireless sensor(s). You can also press [**SENSOR / SYNC**] key to search the on display channel's sensor manually. Once your sensor paired up, the sensor signal strength indicator and weather information will appear on your console display.

SYNC UP PC TIME

This unit is designed to automatically synchronize its calendar and clock when connected to the computer through USB data cable. Once connected to the computer, the unit will automatically synchronize the time instantly and 12:00am per day. You can also press the [**TIME SYNC**] key to sync up PC time instantly.

NOTE:

- PC Time sync up is according to your current PC time, so please ensure your PC time is correct. Once the PC time sync up the  icon will appear in the Time section.
- You can also enable or disable auto time sync function by press and hold [**TIME SYNC**] key for 8 seconds.

SETTING CLOCK MANUALLY

1. In normal mode, press and hold [**CLOCK SET**] key for 2 seconds to enter clock setting.
2. Press [**^**] or [**v**] key set hour.

3. Press [**CLOCK SET**] key again to enter the next setting.
4. The setting sequence: Hour → Minute → Second → 12/24 hour format → Year → Month → Day → M-D/D-M format → Longitude for Sunrise / Sunset → Latitude for Sunrise / Sunset → time zone for Sunrise / Sunset → Language
5. Press [**CLOCK SET**] key to save and exit the setting mode, or the unit will automatically exit the setting mode 60 seconds later without pressing any key.

Hour > Minute > Second setting		
12/24Hr setting		
Year > Month > Day setting		
M-D/D-M setting		
Longitude for Sunrise / Sunset		Press [CH] key to select the setting of longitude direction or digits Press [GRAPH / Λ] or [HISTORY / V] to change the setting value. (e.g. East/West)
Latitude for Sunrise / Sunset		Press [CH] key to select the setting of latitude direction or digits Press [GRAPH / Λ] or [HISTORY / V] to change the setting value. (e.g. North/South)
Time zone for Sunrise / Sunset		Press [GRAPH / Λ] or [HISTORY / V] key to change the time zone for sunrise/Sunset.
Language		





NOTE:

- The console indicates the specific location's sunrise & sunset time according to the time zone, latitude and longitude you entered. Please input the correct information during the clock setting mode.
- In normal mode, press [**CLOCK SET**] key to switch between year and date display.

OTHER SETTING OF THE CONSOLE

MOON PHASE

The moon phase is determined by the time, date and time zone. The following table explains the moon phase icons of the Northern and Southern hemispheres. Please refer to **ORIENTING THE 5-IN-1 SENSOR TOWARDS SOUTH** section about how to setup for the Southern hemispheres.

Northern hemisphere	Moon Phase	Southern hemisphere
	New Moon	
	Waxing Crescent	
	First quarter	
	Waxing Gibbous	
	Full Moon	
	Waning Gibbous	
	Third quarter	
	Waning Crescent	

SETTING ALARM TIME

1. In normal time mode, press and hold [**ALARM**] key for 2 seconds until the alarm hour digit flashes to enter alarm time setting mode.
2. Press [**GRAPH / Δ**] or [**HISTORY / V**] key to change the value. Press and hold the key for quick-adjust.
3. Press [**ALARM**] key again to step the setting value to Minute with the Minute digit flashing.
4. Press [**GRAPH / Δ**] or [**HISTORY / V**] key to adjust the value of the flashing digit.
5. Press [**ALARM**] key to save and exit the setting.

NOTE:

- In alarm mode, the “” icon will display on the LCD.
- The alarm function will turn on automatically once you set the alarm time.

ACTIVATING ALARM AND TEMPERATURE PRE-ALARM FUNCTION

1. In normal mode, press [**ALARM**] key to show the alarm time for 5 seconds.
2. When the alarm time displays, press [**ALARM**] key again to activate the alarm function.
Or press [**ALARM**] key twice to activate the alarm with ice pre-alarm function.

		
Alarm off	Alarm on	Alarm with ice-alert

NOTE:

Once the ice pre-alert activates, the pre-set alarm will sound and alert light will flash 30 minutes earlier if the outdoor temperature is below -3°C.

When clock reach the alarm time, alarm sound will start.

Where it can be stopped by following operation:

- Auto-stop after 2 minutes alarming if without any operation and the alarm will activate again in the next day.
- By pressing [**SNOOZE / LIGHT**] key to enter snooze that the alarm will sound again after 5 minutes.
- By pressing and hold [**SNOOZE / LIGHT**] key for 2 seconds to stop the alarm and will activate again in the next day

- By pressing [**ALARM**] key to stop the alarm and the alarm will activate again in the next day.



NOTE:

- The snooze could be used continuously in 24 hours.
- During the snooze, the alarm icon “🔔” will keep flashing.

TEMPERATURE / HUMIDITY FUNCTION & TREND

Press [**°C / °F**] key to switch between °C /°F temperature unit.

The temperature / humidity trend indicator shows the trends of changes in the forthcoming few minutes.

Arrow indicator			
Temperature / Humidity trend	Rising	Steady	Falling

NOTE:

- When temperature is below -40°C, the LCD will display “Lo”. If temperature is above 80°C, LCD will display “HI”.
- When humidity is below 1%, LCD will display “Lo”. If humidity is above 99%, LCD will display “HI”.

VIEW THE OUTDOOR CHANNEL (Optional feature with add on extra thermal hygro sensors)

This console is capable to pair with a wireless 5-in-1 sensor and up to 7 wireless thermal-hygro sensors. If you have 2 or more sensors, you can press [**CH**] key to switch between different wireless channels in normal mode, or press and hold [**CH**] key for 2 seconds to toggle auto-cycle mode to display the connected channels at 4 seconds interval.

During auto-cycle mode, press [**CH**] key to stop the auto cycle and display the current channel.

WIRELESS SENSOR SIGNAL RECEIVING

1. In normal mode, press [**SENSOR / SYNC**] key once to start receiving the sensor signal of current on displaying channel. The signal icon will flash.
 - For example, when CH 1 is displayed, pressing [**SENSOR / SYNC**] key will start receive for CH 1 only.
2. The signal icon will flash until the reception succeeded. If no signal is received within 5 minutes the icon will disappear.

		
No signal	Weak signal	Good signal

3. If the signal for outdoor channel has discontinued and does not recover within 15 min, the signal icon will disappear. The temperature and humidity will display “--” for the corresponding channel.
4. If the signal does not recover within 48 hours, the “--” display will become permanent you need to replace the batteries of “--” channel’s sensor(s) and then press [**SENSOR / SYNC**] key to pair up the sensors of each “--” channels again.

NOTE:

After replacing the batteries of the wireless sensor or the unit fails to receive sensor signal of a specified channel. During the failed channel is displaying, press [**SENSOR / SYNC**] key to manually receive that sensor signal again.

COMFORT INDICATION

The comfort indication is a pictorial indication based on indoor air temperature and humidity in an attempt to determine comfort level.

☹️	😊	☹️🔥
Too cold	Comfortable	Too hot

NOTE:

Comfort indication can vary under the same temperature, depending on the humidity. There is no comfort indication when temperature is below 0°C (32°F) or over 60°C (140°F).

WIND

Viewing Wind Direction

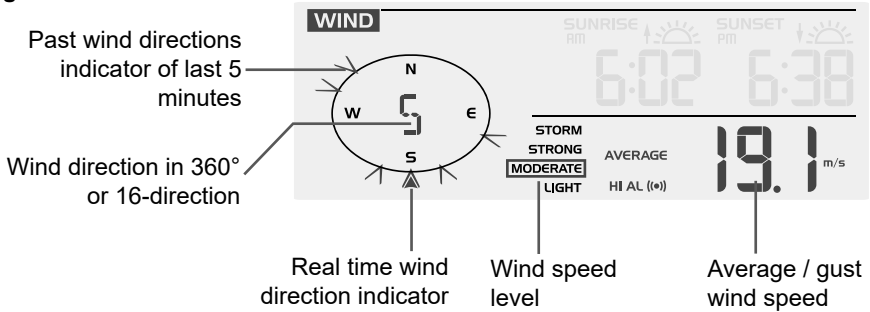

To select the wind display mode

In normal mode, press [**WIND**] key to switch between **AVERAGE** and **GUST** wind speed.

To set the wind speed unit and direction display format

1. In normal mode, press and hold [**WIND**] key for 2 seconds to enter into wind speed unit mode and the unit will flash. And then press [**GRAPH / Δ**] or [**HISTORY / V**] key to change the wind speed unit in this sequence: m/s → km/h → knots → mph
2. Press [**WIND**] key again to enter into wind direction display format setting mode. The wind direction reading will flash and then press [**GRAPH / Δ**] or [**HISTORY / V**] key to select the display format between 360° and 16-direction.
3. Press [**WIND**] key again to return to normal mode.

Wind Speed Level

Level	LIGHT	MODERATE	STRONG	STORM
Speed	0.1km/h ~19km/h	20km/h ~ 49km/h	50km/h ~ 88km/h	> 89km/h

WEATHER INDEX

At the WEATHER INDEX section, you can press [**INDEX**] key to view the weather index in this sequence: **BEAUFORT** → **WIND CHILL** → **HEAT INDEX** → **DEWPOINT**.

Beaufort Scale

The Beaufort scale is an international scale of wind velocities ranging from 0 (calm) to 12 (Hurricane force).



Beaufort Scale	Description	Wind Speed	Land Condition
0	Calm	< 1 km/h	Calm. Smoke rises vertically.
		< 1 mph	
		< 1 knot	
		< 0.3 m/s	
1	Light air	1.1 ~ 5km/h	Smoke drift indicates wind direction. Leaves and wind vanes are stationary.
		1 ~ 3 mph	
		1 ~ 3 knot	
		0.3 ~ 1.5 m/s	
2	Light breeze	6 ~ 11 km/h	Wind felt on exposed skin. Leaves rustle. Wind vanes begin to move.
		4 ~ 7 mph	
		4 ~ 6 knot	
		1.6 ~ 3.3 m/s	
3	Gentle breeze	12 ~ 19 km/h	Leaves and small twigs constantly moving, light flags extended.
		8 ~ 12 mph	
		7 ~ 10 knot	
		3.4 ~ 5.4 m/s	
4	Moderate breeze	20 ~ 28 km/h	Dust and loose paper raised. Small branches begin to move.
		13 ~ 17 mph	
		11 ~ 16 knot	
		5.5 ~ 7.9 m/s	
5	Fresh breeze	29 ~ 38 km/h	Branches of a moderate size move. Small trees in leaf begin to sway.
		18 ~ 24 mph	
		17 ~ 21 knot	
		8.0 ~ 10.7 m/s	
6	Strong breeze	39 ~ 49 km/h	Large branches in motion. Whistling heard in overhead wires. Umbrella use becomes difficult. Empty plastic bins tip over.
		25 ~ 30 mph	
		22 ~ 27 knot	
		10.8 ~ 13.8 m/s	
7	High wind	50 ~ 61 km/h	Whole trees in motion. Effort needed to walk against the wind.
		31 ~ 38 mph	
		28 ~ 33 knot	
		13.9 ~ 17.1 m/s	
8	Gale	62 ~ 74 km/h	Some twigs broken from trees. Cars veer on road. Progress on foot is seriously impeded
		39 ~ 46 mph	
		34 ~ 40 knot	
		17.2 ~ 20.7 m/s	
9	Strong gale	75 ~ 88 km/h	Some branches break off trees, and some small trees blow over. Construction / temporary signs and barricades blow over.
		47 ~ 54 mph	
		41 ~ 47 knot	
		20.8 ~ 24.4 m/s	
10	Storm	89 ~ 102 km/h	Trees are broken off or uprooted, structural damage likely.
		55 ~ 63 mph	
		48 ~ 55 knot	
		24.5 ~ 28.4 m/s	

11	Violent storm	103 ~ 117 km/h	Widespread vegetation and structural damage likely.
		64 ~ 73 mph	
		56 ~ 63 knot	
		28.5 ~ 32.6 m/s	
12	Hurricane force	≥ 118 km/h	Severe widespread damage to vegetation and structures. Debris and unsecured objects are hurled about.
		≥ 74 mph	
		≥ 64 knot	
		≥ 32.7m/s	

Wind Chill

A combination of the wireless outdoor sensor's temperature and wind speed data determines the current wind chill factor.

Heat Index

The heat index, which is determined by the wireless outdoor sensor's temperature & humidity data, when the temperature is between 27°C (80°F) and 50°C (120°F).







Heat Index range	Warning	Explanation
27°C to 32°C (80°F to 90°F)	Caution	Possibility of heat exhaustion
33°C to 40°C (91°F to 105°F)	Extreme Caution	Possibility of heat dehydration
41°C to 54°C (106°F to 129°F)	Danger	Heat exhaustion likely
≥55°C (≥130°F)	Extreme Danger	Strong risk of dehydration / sun stroke

Dew point

- The dew point is the temperature below which the water vapor in air at constant barometric pressure condenses into liquid water at the same rate at which it evaporates. The condensed water is called *dew* when it forms on a solid surface.
- The dew point temperature is determined by the temperature & humidity data from wireless outdoor sensor.

WEATHER FORECAST

The built-in barometer can notice atmosphere pressure changes. Based on the data collected, it can predict the weather conditions in the forthcoming 12~24 hours within a 30~50km (19~31 miles) radius.

					
Sunny	Partly cloudy	Cloudy	Rainy	Rainy / Stormy	Snowy

NOTE:

- The accuracy of a general pressure-based weather forecast is about 70% to 75%.
- The weather forecast is reflecting the weather situation for next 12~24 hours, it may not necessarily reflect the current situation.
- The **SNOWY** weather forecast is not based on the atmospheric pressure, but based on the temperature of current channel. When the outdoor temperature is below -3°C (26°F), the **SNOWY** weather indicator will be displayed on the LCD.

BAROMETRIC PRESSURE

The atmospheric pressure is the pressure at any location of the earth caused by the weight of the column of air above it. One atmospheric pressure refers to the average pressure and gradually decreases as altitude increases. Meteorologists use barometers to measure atmospheric pressure. Since variation in atmospheric pressure greatly affected by weather, it is possible to forecast the weather by measuring the changes in pressure.



To set the barometer unit and select the wind display mode

1. In normal mode, press [**BARO**] key to change the barometer unit in this sequence: hPa → inHg → mmHg
2. In normal mode, press and hold [**BARO**] key to switch between **ABSOLUTE / RELATIVE** display.

Absolute	The absolute atmospheric pressure of your location.
Relative	The relative atmospheric pressure based on the sea level

To set the RELATIVE atmospheric pressure value

1. Obtain the atmospheric pressure data of the sea level (it is also the relative atmospheric pressure data of your home area) through the local weather service, internet or any weather information source.
2. In normal mode, press and hold [**BARO**] key for 2 seconds until “**ABSOLUTE**” or “**RELATIVE**” icon flashes.
3. Press [**GRAPH / Δ**] or [**HISTORY / V**] key to switch to “**RELATIVE**” mode.
4. Press [**BARO**] key once again, the “**RELATIVE**” atmospheric pressure digit flashes.
5. Press [**GRAPH / Δ**] or [**HISTORY / V**] key to change its value.
6. Press [**BARO**] key to save and exit the setting mode.

NOTE:

- When you change the RELATIVE atmospheric pressure value, the weather indicators will change along with it.
- The RELATIVE atmospheric pressure is based on the sea-level pressure you entered but it will change with the absolute atmospheric pressure after operating the clock for 1 hour.

RAINFALL

The **RAINFALL** section shared same display location of **BAROMETRIC PRESSURE** section in the LCD display. It shows the rainfall and rain rate information



To set the rainfall unit

1. Press and hold [**RAIN**] key for 2 seconds to enter unit setting mode.
2. Press [**GRAPH / Δ**] or [**HISTORY / V**] key to toggle the rainfall unit between mm and in.
3. Press [**RAIN**] key to confirm and exit the setting.

To select the rainfall display mode

Press [**RAIN**] key to toggle between:

1. **HOURLY** - the total rainfall in the past hour
2. **DAILY** - the total rainfall from midnight
3. **WEEKLY** - the total rainfall of the current week

4. **MONTHLY**- the total rainfall of the current calendar month
5. **Rate** - Current rainfall rate in past an hour (Update every 24 seconds)
6. **Accumulate** - the total rainfall since the last reset (Show the record starting date on the display for 5 seconds)

To reset the accumulate rainfall record

In normal mode, press and hold [°C / °F] key for 2 seconds to reset the **Accumulate** rainfall record.

NOTE:

To ensure correct data, please reset the **Accumulate** rainfall when you reinstall your wireless outdoor sensor to other location

HISTORY GRAPH

To view different graphs

In normal mode, press [GRAPH / \wedge] key to toggle between different types of graph:

Weather variable	Unit of measure	Record time range	Graph
Barometric pressure	hPa, inHg and mmHg	Past 72 hours	
Indoor temperature	°F or °C	Past 72 hours	
Outdoor temperature (According to the current channel)	°F or °C	Past 72 hours	
Indoor humidity	%	Past 72 hours	
Outdoor humidity (According to the current channel)	%	Past 72 hours	

Rainfall	mm or in	Past 7 days (daily)	
----------	----------	---------------------	--

MAX / MIN DATA RECORD

The console can record the accumulated and daily MAX / MIN weather data with the corresponding time stamp for you to easy review.

To view the daily MAX / MIN

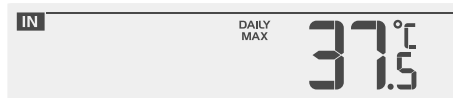

Daily max record of indoor temperature

In normal mode, press [**MAX / MIN**] key to check daily MAX/MIN records. The display sequence is: indoor daily MAX temperature → indoor daily MIN temperature → indoor daily MAX humidity → indoor daily MIN humidity → outdoor daily MAX temperature of current display channel → outdoor daily MIN temperature of current display channel → outdoor daily MAX humidity of current display channel → outdoor daily MIN humidity of current display channel → daily MAX average wind speed → daily MAX gust → daily MAX Beaufort → daily MAX dew point → daily MIN dew point → daily MAX wind chill → daily MIN wind chill → daily MAX heat index → daily MIN heat index → daily MAX pressure → daily MIN pressure → daily MAX rainfall.

To view the accumulated MAX/MIN

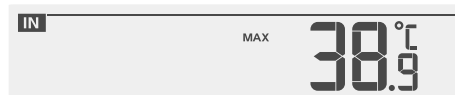

Accumulated max record of indoor temperature

When daily MAX/MIN records shown, press [**GRAPH / ^**] or [**HISTORY / v**] key to show the accumulated MAX/MIN record of the current weather data.

To Clear the MAX/MIN records

Press and hold [**MAX / MIN**] key for 2 seconds to reset the MAX/MIN records of specify weather display section.

PAST 24 HOURS HISTORY DATA

The console automatically stores the weather data of the past 24 hours.

1. Press [**HISTORY / v**] key to check the beginning of the current hour's weather data, e.g. the current time is 7:25 am, March 8, the display will show the data of 7:00am, March 8.
2. Press [**HISTORY / v**] key repeatedly to view older readings of the past 24 hours, e.g. 6:00am (Mar 8), 5:00am (Mar 8), ..., 10:00am (Mar 7), 9:00am (Mar 7), 8:00am (Mar 7)

NOTE:

The LCD will also display the history data records with time & date.

WEATHER ALERT SETTING

Weather Alert can alert you of certain weather conditions. Once the alert criterion is met, the alarm sound will activate and the LCD's alert icon will flash.

To set alert

1. Press [**ALERT**] to select and display the desired weather alert reading in the sequence below:

Alert reading Sequence	Setting Range	Display Section	Default Value
Outdoor Temperature High Alert (current channel)	-40°C ~ 80°C	Outdoor temperature & humidity	40°C
Outdoor Temperature Low Alert (current channel)			0°C
Outdoor Humidity High Alert	1% ~ 99%		80%
Outdoor Humidity Low Alert			40%
Indoor Temperature High Alert	-40°C ~ 80°C	Indoor temperature & humidity	40°C
Indoor Temperature Low Alert			0°C
Indoor Humidity High Alert	1% ~ 99%		80%
Indoor Humidity Low Alert			40%
Wind Speed	0.1m/s ~ 50m/s	Wind direction & speed	17.2mm/h
Pressure Drop	1hPa ~ 10hPa	Barometer & Rainfall	3hPa
Hourly Rainfall	1mm ~ 1000mm		100mm
Wind Chill Low Alert	-40°C ~ 60°C	Weather index	0°C
Dew point High Alert			10°C
Dew point Low Alert	-10°C		
Heat index High Alert	27°C ~ 49°C		35°C
Beaufort scale High Alert	1 ~ 12		6

2. Under the current alert reading, press and hold [**ALERT**] key for 2 seconds to enter alert setting and the alert reading will flash.
3. Press [**GRAPH / \wedge**] or [**HISTORY / \vee**] key to adjust the value or press and hold the key to change rapidly.
4. Press [**ALERT**] key to save the alert reading then press [**ALARM**] key to toggle the regarding alert on / off.



5. Press any key on the front side to save and back to normal mode, or it will automatically back to normal mode after 30 seconds without pressing any key.

To silence the alert alarm:

Press [**SNOOZE / LIGHT**] key to silence the alert alarm or let the alarm automatically turn off after 2 minutes.

NOTE:

- Once the alert is triggered, the alarm will sound for 2 minutes and the related alert icon and readings will flash.

- If the alert alarm is automatically off after 2 minutes, the alert icon and readings will still keep flash until the weather reading is out of the alert range.
- The weather alert will sound again when the weather readings falls into the alert range again.

POINTING THE WIRELESS 5-IN-1 SENSOR TO SOUTH

The outdoor 5-in-1 sensor is calibrated to point to North for the maximum accuracy. However, for the user's convenience (e.g. users in the Southern hemisphere), it is possible to use the sensor with the wind vane pointing to South.

1. Install the 5-in-1 wireless sensor with its wind meter end pointing to South. (Please refer to **INSTALLATION OF THE WIRELESS SENSOR** for mounting details)
2. In normal mode of the console, press and hold [**INDEX**] key for 8 seconds to enter into the calibration mode, then press [**INDEX**] key again until the "N" icon appears on the weekday location to enter into the sensor orientation mode
3. Use [**GRAPH / \wedge**] or [**HISTORY / \vee**] key to change to "S" (Southern Hemisphere).
4. Press [**INDEX**] key to confirm and exit.

NOTE:

- Changing the hemisphere setting will automatically switch the direction of the moon phase on the display.

DATA LOG

The console automatically stores the weather data in its data logger (default every 30 minutes), and user can export these data through the PC software* (*Please consult your local distributor for the PC software download).

To check data logger memory

Press the [**DATA**] key to briefly review the remaining number of days the console is able to record based on its current free memory available (e.g. 300 DAY). The data logger will stop recording new data once its memory is full.

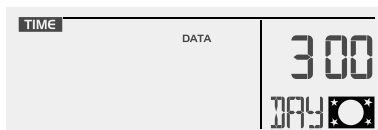

To change data interval and clear data

In normal mode, press and hold the [**DATA**] key for 2 sec to enter data logger setting mode.

1. To change data interval: Press [**GRAPH / \wedge**] or [**HISTORY / \vee**] key to select frequency of data recording (5/15/30/60 minutes), then press [**DATA**] to confirm.

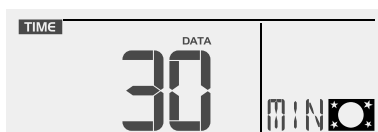

Below table shown the number of days memory will allow for records:

INTERVAL (minutes)	NO. OF DAYS AVAILABLE FOR DATA LOGGING WITH MEMORY AVAILABLE
5	50
15	150
30 (DEFAULT)	300
60	600

- To clear data: Press [**GRAPH / Λ**] or [**HISTORY / V**] key to select clear all data or not, then press [**DATA**] to confirm and exit setting.

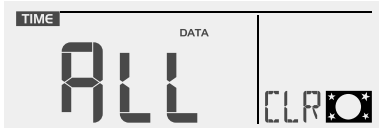

All data selected for clear

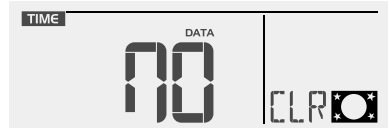

No data selected

NOTE:

- To avoid the wrong time stamp of the data record, please reset the data logger once replace the batteries in main unit or sensor(s).
- When the data log is almost full, "DATA" icon keep flashes to remind you to transfer the data to PC for storage. Otherwise, data logger cannot log any more data when it is full.

PC SOFTWARE

This console can display live data and export the weather data to the Windows base PC through the "Weather Tool" software. Please consult your local distributor for download details.



"Weather Tool" software icon

To connect PC

- Download Weather Tool.exe file on your windows desktop and then double click to run it.
- Plug the small end of the USB cable to USB port on the console and the big end of the cable into the USB port of the PC.

If the console is connected successfully, "USB" icon will appear on display, and its time and date will be synchronized to that of PC momentarily, as indicated by the "📶" icon.



Instant live data from the console will be transmitted to the dashboard screen on the PC.



Dashboard page

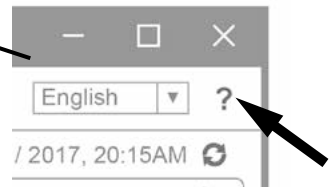

In the PC software, click on "?" icon located at the top right hand corner for details of operations and settings of "Weather Tool" program.

Uninstall the Weather Tool

To uninstall the Weather Tool, just delete the **Weather Tool.exe** file from your PC.

NOTE: .



- Please use the USB cable provided to connect the console to PC.
- Please keep the USB cable connected, during the data exporting to your PC.
- The Microsoft Windows and worksheet software are 3rd party softwares, the interface and operation flow maybe different in various software version.
- The USB cable will supply power to the console while in connection with the PC.

MAINTENANCE

BATTERY REPLACEMENT

If the low battery indicator “” displayed in time section, it indicates that the console battery power is low. You should replace all the batteries in the console at once

If the low battery indicator “” displayed in outdoor section, it indicates that the current channel wireless outdoor sensor battery power is low. You should replace all the batteries in the current channel sensor at once.

	
Low battery indicator for main unit	Low battery indicator for wireless sensor

CLEANING THE RAIN COLLECTOR

1. Unscrew the rain collector by turning it 30° anti-clockwise.
2. Gently remove the rain collector.
3. Clean and remove any debris or insects.
4. Install the collector when it is clean and fully dried.

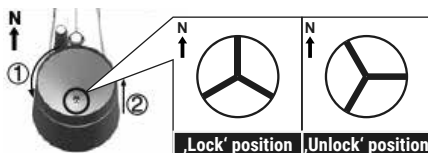

CLEANING THERMO-HYGROSENSOR OF WIRELESS 5-IN-1 SENSOR

1. Remove the 2 screws at the bottom of the radiation shield.
2. Gently pull out the shield.
3. Carefully remove any dirt or insects on the sensor casing (do not let the sensors inside get wet).
4. Clean the shield with water to remove any dirt or insects.
5. Install all the parts back when they are clean and fully dried.

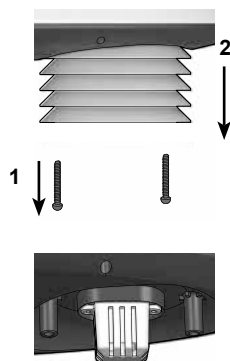

PRECAUTIONS

- Keep and reading the “User manual” is highly recommended. The manufacturer and supplier cannot accept any responsibility for any incorrect readings, export data lost and any consequences that occur should an inaccurate reading take place.
- Do not subject the unit to excessive force, shock, dust, temperature or humidity.
- Do not cover the ventilation holes with any items such as newspapers, curtains etc.
- Do not immerse the unit in water. If you spill liquid over it, dry it immediately with a soft, lint-free cloth.
- Do not clean the unit with abrasive or corrosive materials.
- Do not tamper with the unit’s internal components. This invalidates the warranty.
- Only use fresh batteries. Do not mix new and old batteries.
- Only use attachments / accessories specified by the manufacturer.
- Images shown in this manual may differ from the actual display.
- When disposing of this product, ensure it is collected separately for special treatment.
- Placement of this product on certain types of wood may result in damage to its finishing for which manufacturer will not be responsible. Consult the furniture manufacturer’s care instructions for information.
- The contents of this manual may not be reproduced without the permission of the manufacturer.
- When replacement parts are required, be sure the service technician uses replacement parts specified by the manufacturer that have the same characteristics as the original parts. Unauthorized substitutions may result in fire, electric shock, or other hazards.
- Do not dispose old batteries as unsorted municipal waste. Collection of such waste separately for special treatment is necessary.
- This product is not a toy. Keep out of the reach of children.
- The main console is intended to be used only indoors.
- Technical specifications and user manual contents for this product are subject to change without notice.



SPECIFICATIONS

MAIN CONSOLE

General Specification

Dimensions (W x H x D)	117 x 189 x 31mm (4.6 x 7.5 x 1.2in)
Weight	480g (with batteries)
Battery	6 x AA size 1.5V batteries (alkaline recommended)
Weather data in console	Baro, temperature and humidity
Operating temperature range	-5°C ~ 50°C

Personal computer requirements for PC software

Connection interface	USB 2.0
Operation system of your PC	Windows XP, Windows Vista, Windows 7 or latest version (32-bit / 64-bit)
Hard disk space	50 MB
Display resolution	1360 x 768 (1920 x 1080 recommended)
View or edit export data	Microsoft excel or other similar software for PC
Weather Underground upload requirements	- Should able connect to Internet - Firewall and anti virus software can set permission for the PC software

Wireless Sensor side Communication Specification

Support sensors	Wireless 5-in-1 weather outdoor sensor and up to 7 optional wireless hygro-thermo outdoor sensors
RF frequency	868MHz
Max. transmission power	< 25mW
RF transmission range	100m

Time Related Function Specification

Time display	HH: MM: SS
Hour format	12 hour or 24 hour
Date display	DD / MM or MM / DD
Time synchronize method	PC time (only available when connected to Windows base PC)
Weekday languages	EN / DE / FR / ES / IT / NL / RU

Barometer Display & Function Specification

Note: The following details are listed as they are displayed or operate on the console.

Barometer unit	hPa, inHg and mmHg
Measuring range	540 ~ 1100hPa (relative setting range 930 ~ 1050hPa)
Accuracy	(700 ~ 1100hPa ± 5hPa) / (540 ~ 696hPa ± 8hPa) (20.67 ~ 32.48inHg ± 0.15inHg) / (15.95 ~ 20.55inHg ± 0.24inHg) (525 ~ 825mmHg ± 3.8mmHg) / (405 ~ 522mmHg ± 6mmHg) Typical at 25°C (77°F)
Resolution	1hPa / 0.01inHg / 0.1mmHg

Weather forecast	Sunny, Partly Cloudy, Cloudy, Rainy, Rainy / Stormy and Snowy
Display modes	Current
Memory modes	Historical data from last memory reset, daily Max / Min
Alarm	Pressure change alert

Indoor / Outdoor Temperature Display & Function Specification

Note: The following details are listed as they are displayed or operate on the console.

Temperature unit	°C and °F
Display range	-40 ~ 80°C (-40 ~ 176°F)
Indoor Accuracy	>40°C ± 2°C (>104°F ± 3.6°F) 0~40°C ±1°C (32~104°F ± 1.8°F) <0°C ± 2°C (<32°F ± 3.6°F)
Outdoor Accuracy	55 ~ 60°C ± 0.5°C (131 ~ 140°F ± 0.9°F) 10 ~ 55°C ± 0.4°C (50 ~ 131°F ± 0.7°F) -20 ~ 10°C ± 1.3°C (-4 ~ 50°F ± 2.3°F) -40 ~ -20°C ± 1.9°C (-40 ~ -4°F ± 3.4°F)
Resolution	0.1°C / 0.1°F
Display modes	Current
Memory modes	Historical data from last memory reset, daily Max / Min
Alarm	Hi / Lo temperature alert

Indoor / Outdoor Humidity Display & Function Specification

Note: The following details are listed as they are displayed or operate on the console.

Humidity unit	%
Display range	1 ~ 99%
Indoor Accuracy	20~39% RH ±8%RH @ 25°C (77°F) 40~70% RH ±5%RH @ 25°C (77°F) 71~90% RH ±8%RH @ 25°C (77°F)
Outdoor Accuracy	1 ~ 90% RH ± 2.5% RH @ 25°C (77°F) 90 ~ 99% RH ± 3.5% RH @ 25°C (77°F)
Resolution	1%
Display modes	Current
Memory modes	Historical data from last memory reset, daily Max / Min
Alarm	Hi / Lo Humidity Alert

Wind Speed & Direction Display and Function Specification

Note: The following detail are listed as they are displayed or operate on the console.

Wind speed unit	mph, m/s, km/h and knots
Wind speed display range	0 ~ 112mph, 50m/s, 180km/h, 97knots
Resolution	0.1mph, 0.1m/s, 0.1km/h, 0.1knots
Speed accuracy	±2.2 mph or ±10% (whichever is greater)
Display mode	Gust / Average
Memory modes	Historical Data from last memory reset, daily Max Gust/Average
Alarm	Hi Wind Speed Alert (Average / Gust)
Wind direction resolutions	1 degree

Rain Display & Function Specification

Note: The following details are listed as they are displayed or operate on the console.

Unit for rainfall	mm and in
Accuracy for rainfall	± 7%
Range of rainfall	0 ~ 19999mm (0 ~ 787.3 in)
Resolution	0.254mm (0.01in)
Display modes	Current
Memory modes	Historical Data from last memory reset, daily Max
Rainfall display mode	Hourly / Daily / Weekly / Monthly / Total rainfall
Alarm	Hi Hourly Rainfall Alert

Weather Index Display & Function Specification

Note: The following details are listed as they are displayed or operate on the console

Weather index mode	Beaufort, Wind Chill, Heat Index and Dew point
Beaufort scale	0 ~ 12
Wind Chill range	-40 ~ 18°C, wind speed > 4.8km/h
Heat index range	26 ~ 50 °C
Dew point range	-20 ~ 60°C
Display modes	Current
Memory modes	Historical Data from last memory reset, Daily Max / Min

WIRELESS 5-IN-1 SENSOR

Dimensions (W x H x D)	392.5 x 326 x 144.5mm (15.5 x 12.8 x 5.7in)
Weight	1096g (with batteries)
Main power	3 x AA size 1.5V batteries (Alkaline batteries recommended)
Weather data	Temperature, Humidity, Wind speed, Wind direction, Rainfall
RF transmission range	100m
RF frequency (depend on country version)	868MHz
Max. transmission power	< 25mW
Transmission interval	• 12 seconds for wind speed and wind direction data • 24 seconds for temperature, humidity, rain data
Operating range	-40 ~ 60°C (-40 ~ 140°F) Lithium batteries required



www.bresser.de/start/bresser

Errors and technical changes reserved.
Manual_7002571_PC-Wetterstation_en_BRESSER_v052020a



Bresser GmbH

Gutenbergstr. 2 · DE-46414 Rhede
Germany

www.bresser.de · service@bresser.de